

ALPLUS LOUNGE

FREZZA

Alplus Lounge - Divano modulare



CARATTERISTICHE TECNICHE

design Marco Zito

seduta	struttura interna in multistrato di legno ed imbottitura in poliuretano flessibile ed indeformabile. All'interno del sedile sono previste delle cinghie elastiche incrociate che esaltano la sensazione di comfort della seduta.		
schienale	in multistrato di legno con imbottitura in poliuretano flessibile ed indeformabile.		
pannelli divisori	in multistrato di legno integrato di poliuretano ambo i lati. Disponibile in versione lineare e curva a 60°. I pannelli sono collegati tra loro attraverso una zip per assicurare il perfetto allineamento. Rivestimento in tessuto ed ecopelle, disponibile sia in tinta unita che con combinazione di due colori.		
rivestimenti	il divano può essere rivestito in tessuto o ecopelle ed è disponibile nella versione a tinta unita o con combinazione di due colori.		
accessori	<u>tavolino quadrato</u> con struttura interna in multistrato di faggio, rivestita ai lati in tessuto o ecopelle e piano in melaminico. Può essere utilizzato in combinazione con i moduli divano. <u>tavolino rettangolare</u> con struttura in metallo verniciato goffrato e piano in melaminico. Il tavolino va posto tra i moduli del divano. <u>cuscinio cilindrico</u> divisorio amovibile. Ø 20, L. 60 cm. <u>presa USB</u> (5V A+C) in zama nel cuscino del divano. La presa USB viene installata in posizione centrale.		
finitura base (piedini)	● Nylon nero		
struttura tavolino	Metallo verniciato goffrato ○ ZGBI - Bianco RAL 9010 ● ZGTR - Tortora ● ZGNE - Nero RAL 9005		
piano tavolino quadrato e rettangolare	Melaminico ○ MBI Bianco ● MNE Nero ● MCE Cemento ● MOB Olmo chiaro		
tessuti	Cat. H Madrid 3D ● T3M0 ● T3V0 ● T3V2 ● T3B2 ● T3V4 ● T3M3 ● T3B3		

Cat. D

King Flex



Time



Skill (ecopelle)

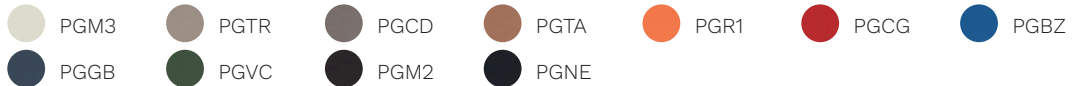

Cat. F

Step

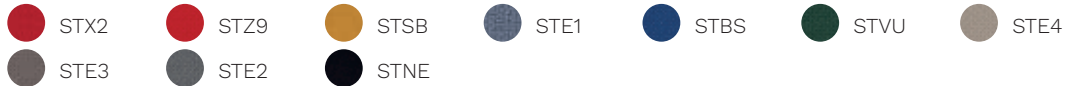

Chili

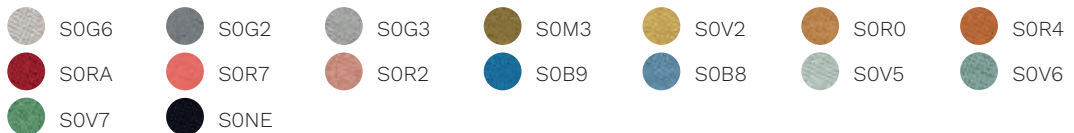

Stromboli



Silververtex

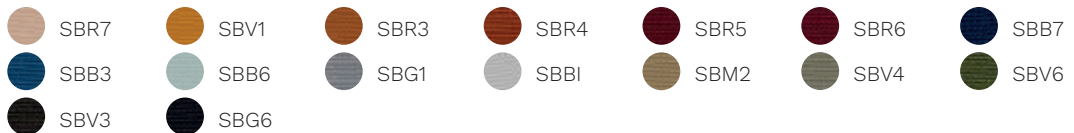

Valencia



Jet



Magnum (ecopelle)

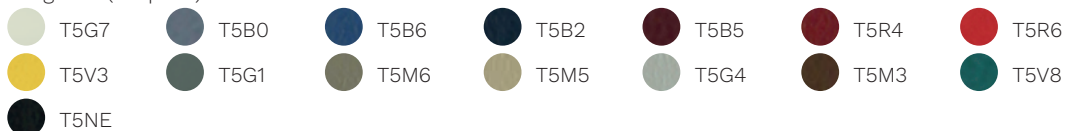

Connect

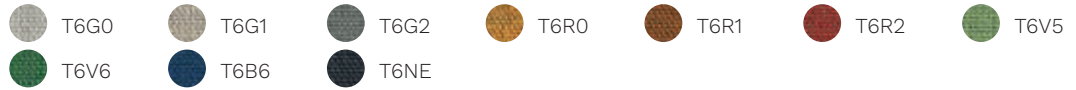

Rivet



Era



Go Check

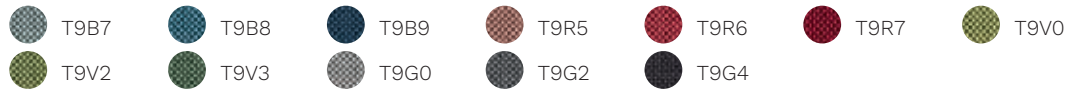

Rondo

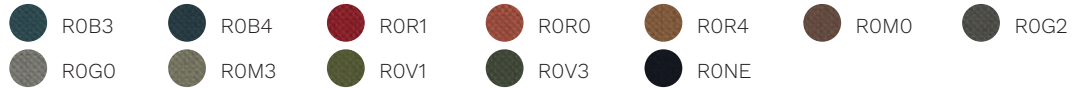

Cat. G

Remix 3



Oceanic

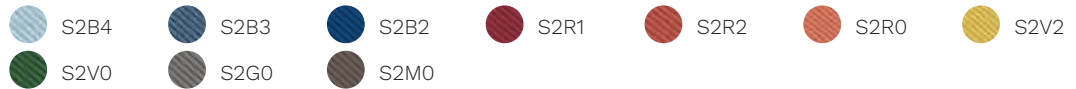

Focus

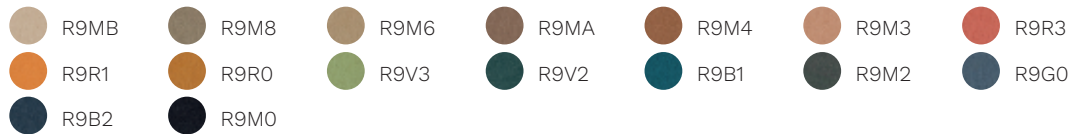

Focus Melange



Aida



Cat. Q

Steelcut Trio 3



Ecriture

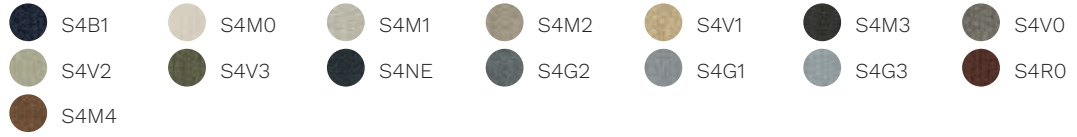

Ombra



ABACO

Pouf

Pouf 1 posto L. 80 cm.

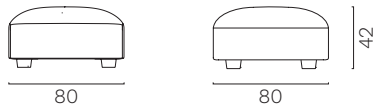

Pouf 2 posti L. 120 cm.

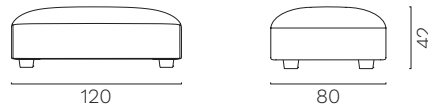

Pouf 3 posti L. 160 cm.

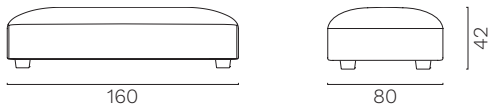

Pouf angolare 60°.

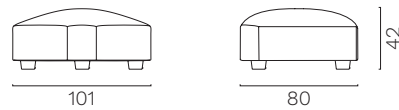

Poltrona

Poltrona 1 posto.

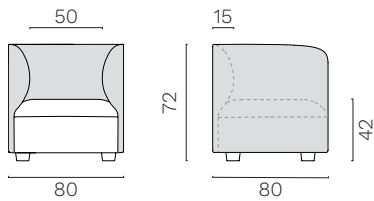

Moduli iniziali

Modulo con bracciolo a destra e schienale L. 80 cm.

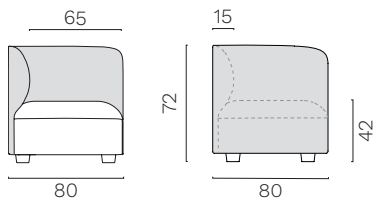

Modulo con bracciolo a destra ridotto L. 120 cm.

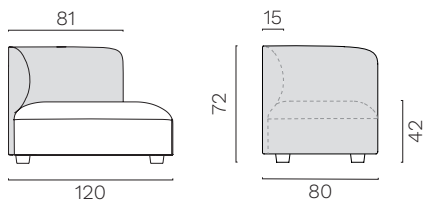

Modulo con bracciolo a destra e schienale ridotto L. 160 cm.

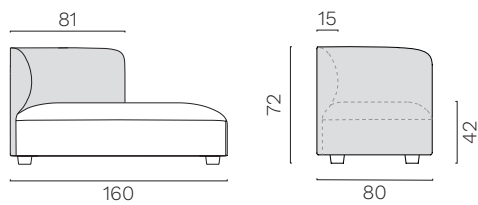

Modulo con bracciolo a destra e schienale L. 120 cm.

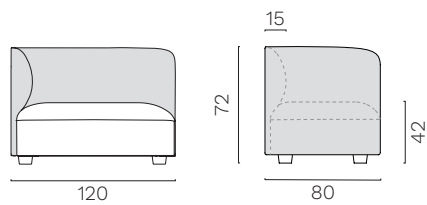

Modulo con braccio a destra e schienale L. 160 cm.

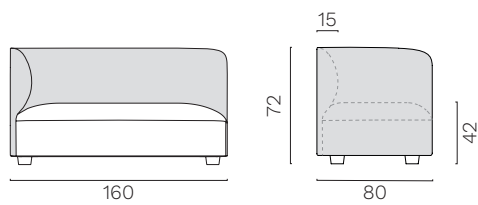

Moduli intermedi

Modulo con schienale L. 80 cm.

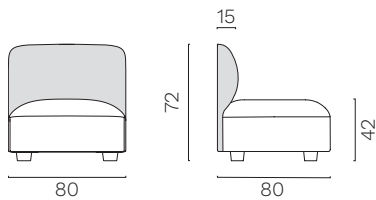

Modulo con schienale L. 120 cm.

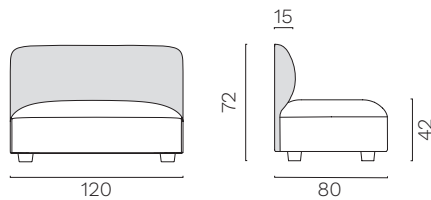

Modulo con schienale L. 160 cm.

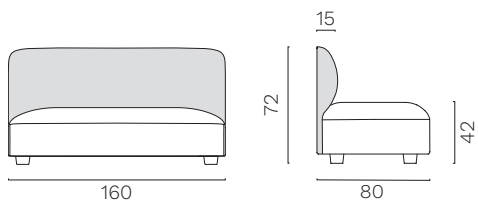

Moduli finali

Modulo con bracciolo a sinistra e schienale L. 80 cm.

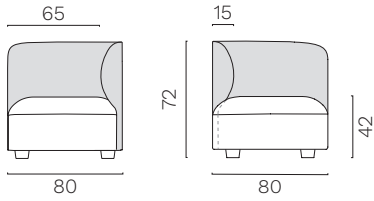

Modulo con bracciolo a sinistra ridotto L. 120 cm.

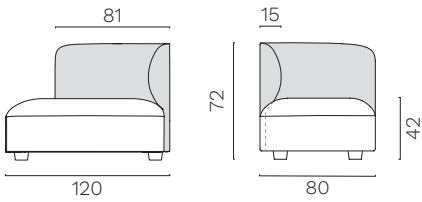

Modulo con bracciolo a sinistra e schienale ridotto L. 160 cm.

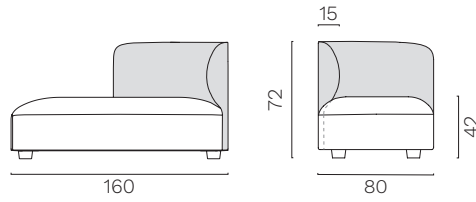

Modulo con bracciolo a sinistra e schienale L. 120 cm.

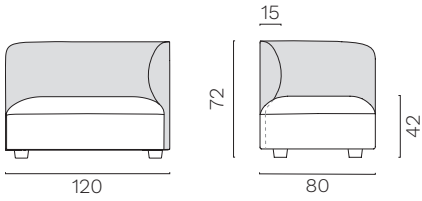

Modulo con bracciolo a sinistra e schienale L. 160 cm.

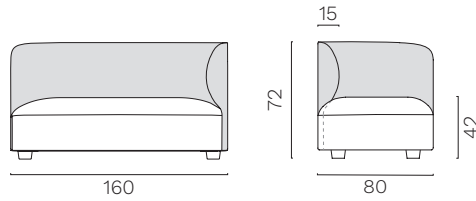

Pannelli divisori L. 60 x H. 130 cm

Pannello divisorio L. 60 cm x H. 130 cm.

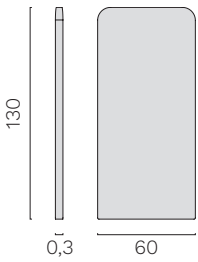

Pannello divisorio iniziale con zip a sinistra L. 60 cm x H. 130 cm.

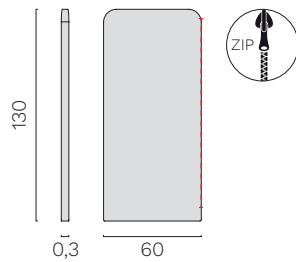

Pannello divisorio intermedio con zip a sinistra e destra L. 60 cm x H. 130 cm.

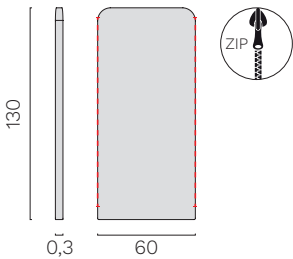

Pannello divisorio finale con zip a destra L. 60 cm x H. 130 cm.

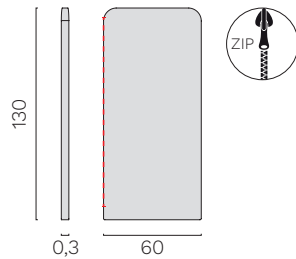

pannelli divisori L. 80 x H. 130 cm

Pannello divisorio L. 80 cm x H. 130 cm.

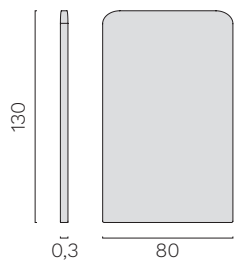

Pannello divisorio iniziale con zip a sinistra L. 80 cm x H. 130 cm.

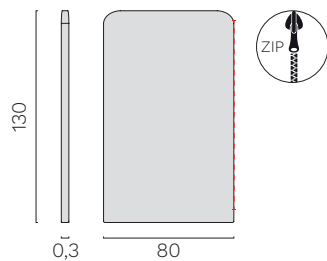

Pannello divisorio intermedio con zip a sinistra e destra L. 80 cm x H. 130 cm.

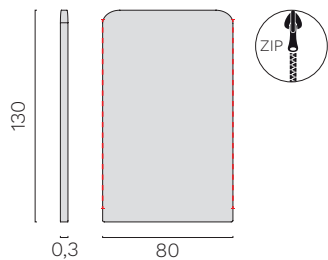

Pannello divisorio finale con zip a destra L. 80 cm x H. 130 cm.

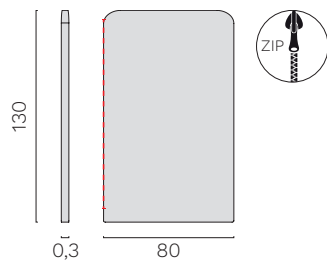

pannelli divisori curvi H. 130 cm

Pannello divisorio curvo con zip a destra per modulo da 60° H. 130 cm.

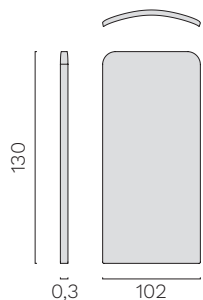

Pannello divisorio curvo iniziale con zip a sinistra per modulo da 60° H. 130 cm.

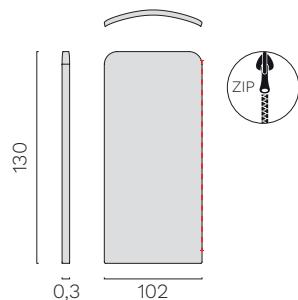

Pannello divisorio curvo con zip su entrambi i lati per modulo da 60° H. 130 cm.

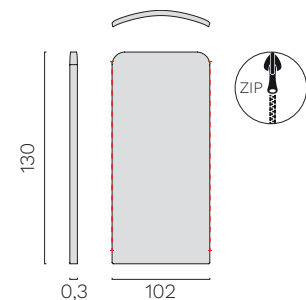

Pannello divisorio curvo finale con zip a destra per modulo da 60° H. 130 cm.

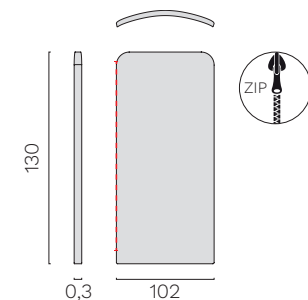

Accessori

Cuscino cilindrico.

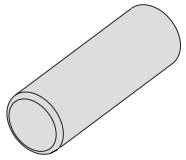

Tavolino quadrato 80x80 cm.

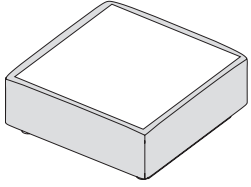

tavolino rettangolare 20x45 cm.

