

ALPLUS LOUNGE

















Alplus Lounge - Modular sofa



TECHNICAL DETAILS

design Marco Zito

seat	internal structure made of plywood frame with flexible, non-deformable polyurethane foam padding. Crossed elastic straps inside the seat cushion enhance the comfortable feeling of the seat.						
backrest	made of plywood frame with flexible, non-deformable polyurethane foam padding.						
privacy panels	made of plywood frame integrated with polyurethane on both sides. Available in linear and 60° curved versions. The panels are connected by a zip to ensure perfect alignment. Upholstery in fabric and eco-leather, available in one colour or a combination of two colours.						
upholsteries	The sofa can be upholstered in fabric or eco-leather and is available in one colour or a combination of two colours.						
accessories	<u>square table</u> with plywood internal structure, upholstered on the sides in fabric or eco-leather and melamine top. It can be used in combination with the sofa modules.						
	<u>rectangular table</u> with embossed painted metal frame and melamine top. The coffee table is placed between the sofa modules.						
	<u>cylindrical dividing cushion</u> - Ø 7" 7/8 x W. 23" 5/8						
	<u>USB socket</u> (5V A+C) in zamak into the sofa cushion. The USB socket is installed in a central position.						
base finish (feet)	 Black nylon						
coffee table structure	Embossed painted metal						
	 ZGBI - White RAL 9010	 ZGTR - Dove Grey	 ZGNE - Black RAL 9005				
top for rectangular or square coffee table	Melamine						
	 MBI White	 MNE Black	 MCE Concrete	 MOB Light elm			
fabrics	Cat. H						
	Madrid 3D						
	 T3M0	 T3V0	 T3V2	 T3B2	 T3V4	 T3M3	 T3B3

Cat. D

King Flex



Time



Skill (eco-leather)

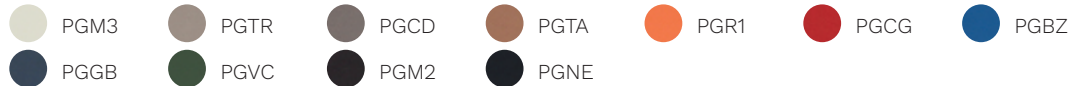

Cat. F

Step



Chili



Stromboli



Silververtex

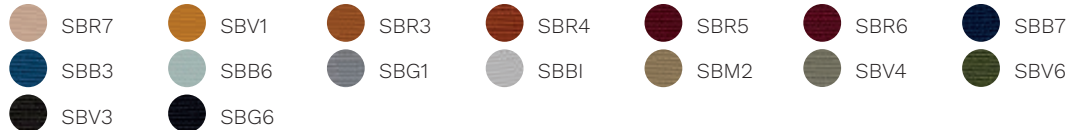

Valencia



Jet



Magnum (eco-leather)

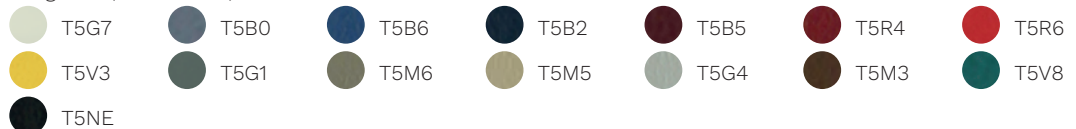

Connect

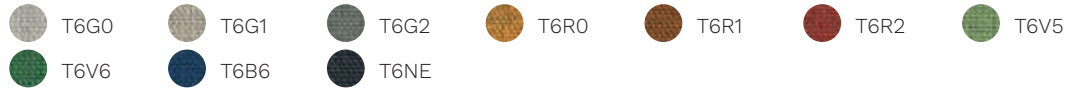

Rivet

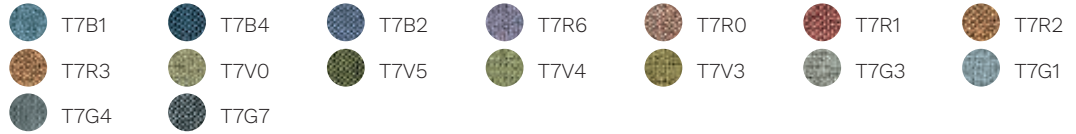

Era



Go Check

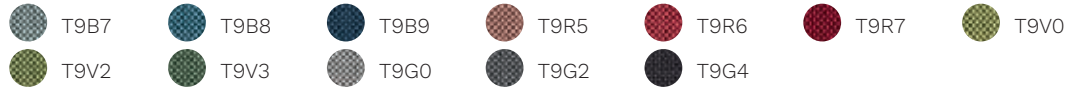

Rondo

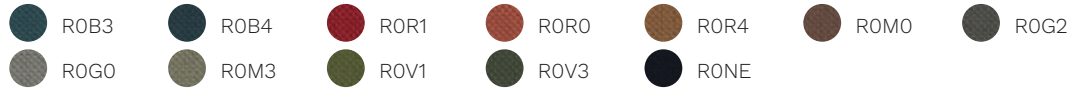

Cat. G

Remix 3



Oceanic

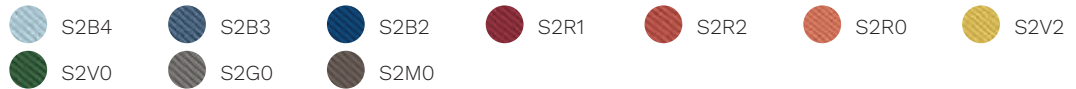

Focus

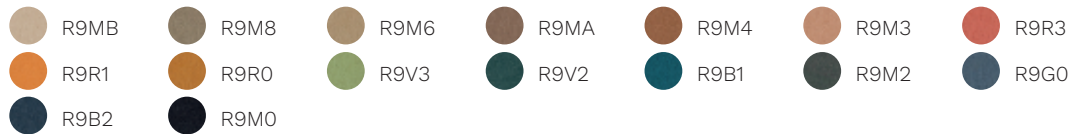

Focus Melange



Aida



Cat. Q

Steelcut Trio 3



Ecriture

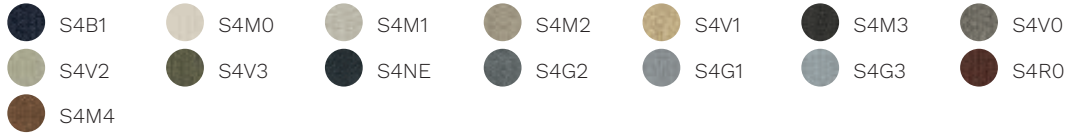

Ombra



ABACUS

Pouf

1-seater pouf - W. 31" 1/2.

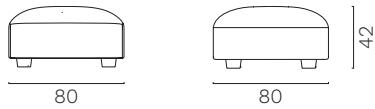

2-seater pouf w.- 47" 1/4.

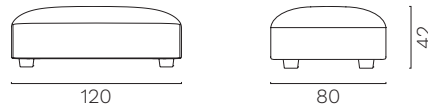

3-seater pouf - w. 63".

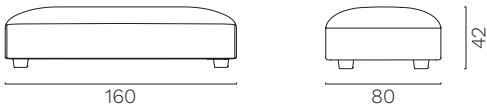

Corner pouf 60°.

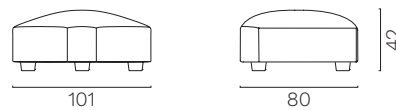

ABACUS

Armchair

1-seater armchair.

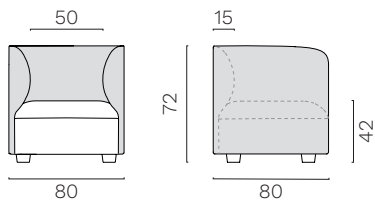

Starting module

Element with Rh armrest and backrest.
W. 31" 1/2.

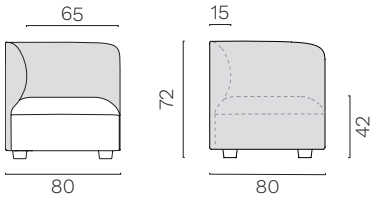

Element with Rh armrest and short backrest
W. 47" 1/4.

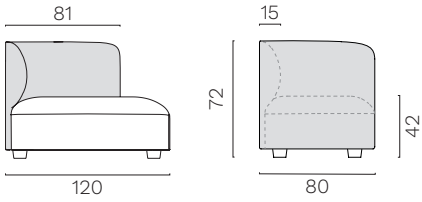

Element with Rh armrest and short backrest W.
63".

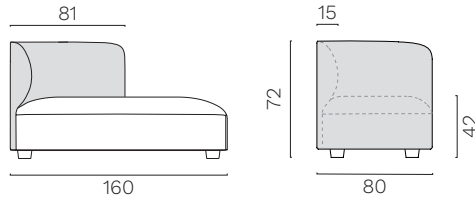

Element with Rh armrest and backrest W.
47" 1/4.

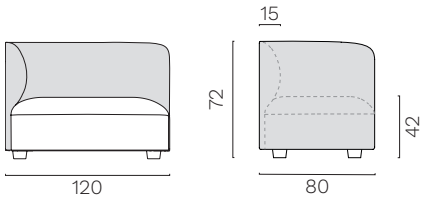

Element with Rh armrest and backrest
W. 63".

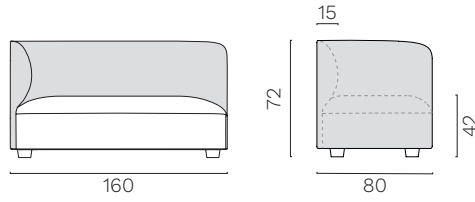

Intermediate module

Module with backrest W. 31" 1/2.

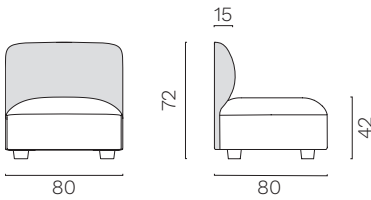

Module with backrest W. 47" 1/4.

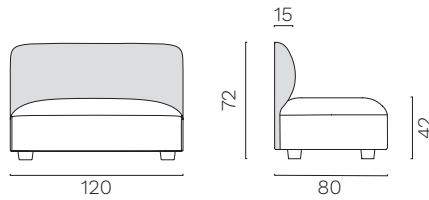

Module with backrest W. 63".

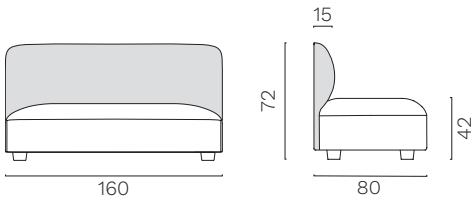

Ending module

Element with Lh armrest and backrest
W. 31" 1/2.

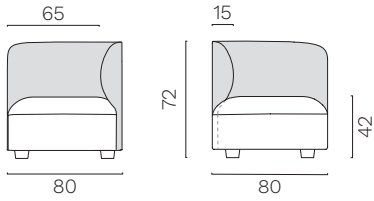

Element with Lh armrest and short backrest
W. 47" 1/4.

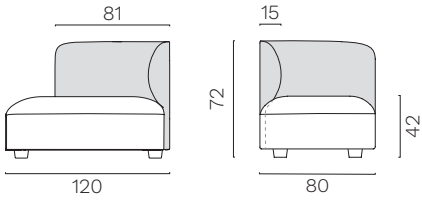

Element with Lh armrest and short backrest W. 63".

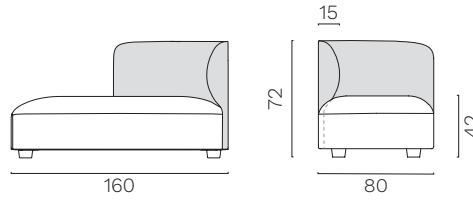

Element with Lh armrest and backrest W.
47" 1/4.

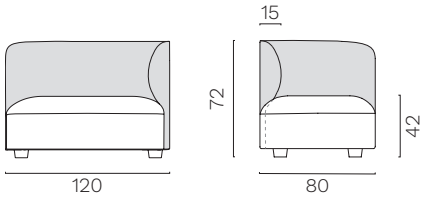

Element with Lh armrest and backrest
W. 63".

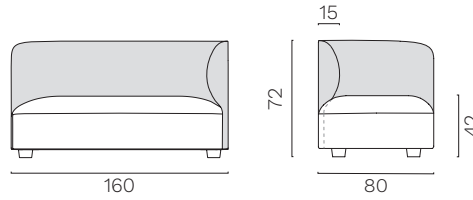

Partition panel - W. 23" 5/8

Partition panel - W. 23" 5/8 x H. 51" 1/8.

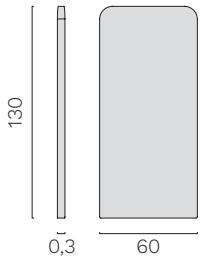

Starting partition panel with Lh zip - W. 23" 5/8 x H. 51" 1/8.

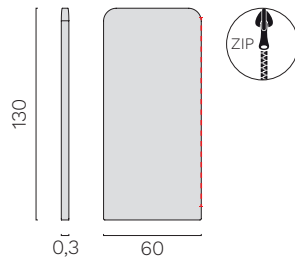

Central partition panel with Lh/Rh zip - W. 23" 5/8 x H. 51" 1/8.

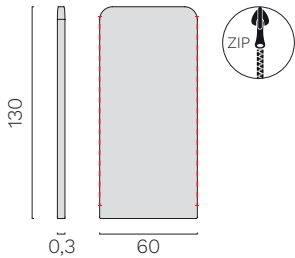

Ending partition panel with Rh zip - W. 23" 5/8 x H. 51" 1/8.

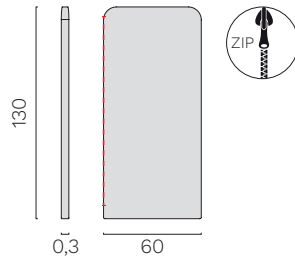

Partition panel - W. 31" 1/2 x H. 51" 1/8

Partition panel - W. 31" 1/2 x H. 51" 1/8.

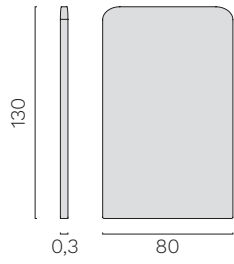

Starting partition panel with Lh zip - W. 31" 1/2 x H. 51" 1/8.

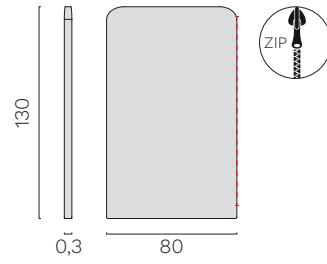

Central partition panel with Lh/Rh zip - W. 31" 1/2 x H. 51" 1/8.

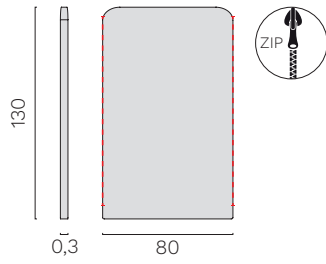

Ending partition panel with Rh zip - W. 31" 1/2 x H. 51" 1/8.

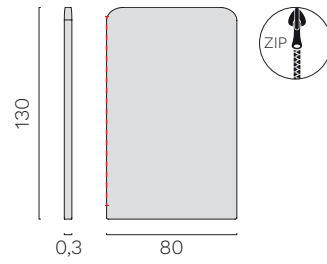

Curved partition panel - H. 51" 1/8

Curved partition panel - H. 51" 1/8.

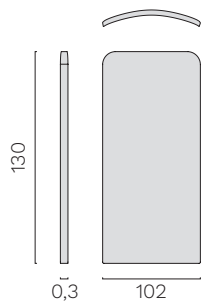

Curved starting partition panel with Lh zip - H. 51" 1/8.

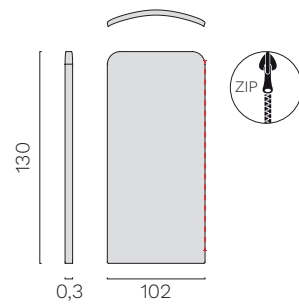

Curved central partition panel with Lh/Rh zip - H. 51" 1/8.

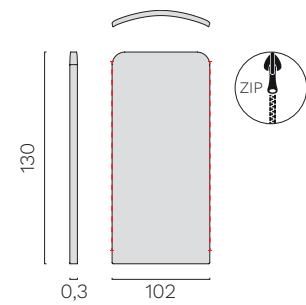

Curved ending partition panel with Rh zip for 60° corner element - H. 51" 1/8.

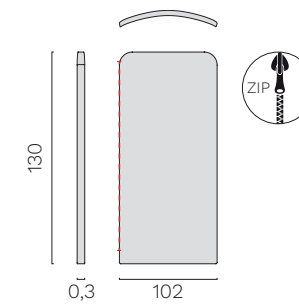

Accessories

Cylindrical cushion.

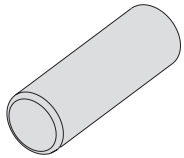

Square table W. 31" 1/2 D. 31" 1/2.

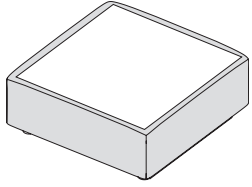

Rectangular table W. 7" 7/8 x D. 19" 5/8.

