

LOL

Task chair

FREZZA



TECHNICAL DETAILS

backrest

in nylon with properly tensioned elastic polyester mesh cover, with height-adjustable lumbar support (50 mm). It allows to personalise the contact between the backrest and the back of the user, particularly in the lower back area, following the natural curves of the spine. Available with medium backrest, with or without headrest.



seat

in beech plywood, CFC free polyurethane foam padding, black polypropylene under seat cover.

headrest

in black nylon with mesh cover, height adjustment (40 mm) to better support the head and relax tense neck muscles.



armrests

fixed: in black nylon

1D adjustable: (height 90 mm) in black soft touch nylon.

2D adjustable: (height 90 mm, depth 46 mm) in black soft touch nylon.



device

synchronised lockable in 4 positions with frontal adjustment of the backrest resistance in relation to the user's weight. This mechanism dynamically follows all the natural movements of the user's body; seat and backrest tilt together, relieving tension on the dorsal muscles. The movement tension is adjustable, adapting to the user's body shape and preferences. The correct seat/back tilt angle ensures proper blood flow while reducing the feeling of heaviness in the lower limbs. A soft release system allows the user to control the movement of the backrest when released.

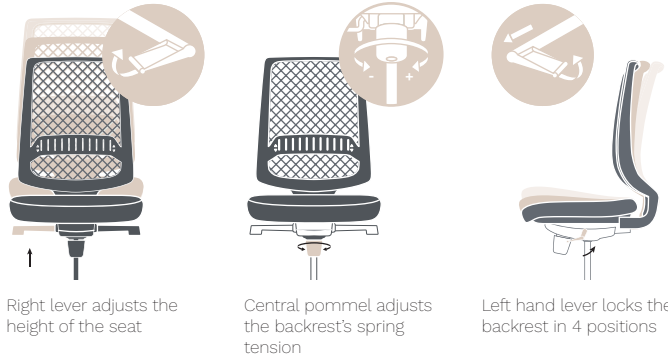

Right lever adjusts the height of the seat

Central pommel adjusts the backrest's spring tension

Left hand lever locks the backrest in 4 positions

device

synchronised lockable in 4 positions with seat depth adjustment (60 mm), with adjustment of the backrest resistance in relation to the user's weight. This mechanism dynamically follows all the natural movements of the user's body; seat and backrest tilt together, relieving tension on the dorsal muscles. The movement tension is adjustable, adapting to the user's body shape and preferences. The correct seat/back tilt angle ensures proper blood flow while reducing the feeling of heaviness in the lower limbs. A soft release system allows the user to control the movement of the backrest when released. The seat depth adjustment provides adequate support for people of different heights and build. The seat can slide forward and backward to change the thigh support base as desired, providing a dynamic alignment of the position of the legs.

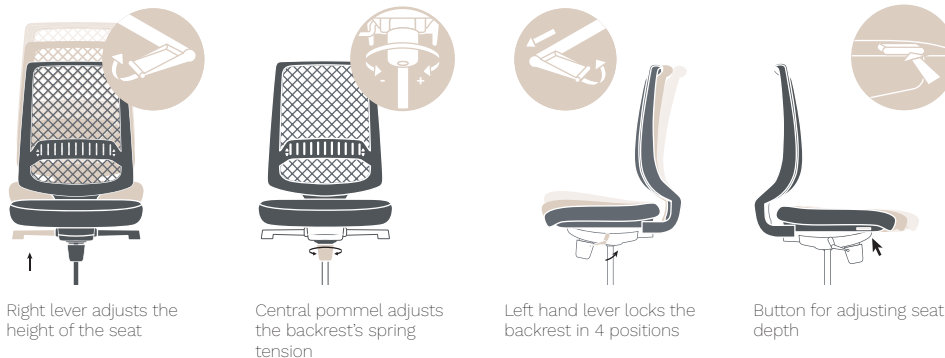

Right lever adjusts the height of the seat

Central pommel adjusts the backrest's spring tension

Left hand lever locks the backrest in 4 positions

Button for adjusting seat depth

height adjustment

by gas lift. Allows an excursion of 12 cm.

base

5-star base in nylon or die-cast aluminium. Self-locking dual-tread rubbered swivel castors, Ø 50 mm.

ergonomics

Lol is equipped with the necessary mechanisms for correct and comfortable use, even for prolonged periods, as long as the following conditions are met: the standard sitting position requires the maintenance of 90° angles between torso and thigh, between thigh and leg and between leg and foot. These last two angles are essential so that the foot, resting completely on the surface underneath, unloads part of the weight of the lower limb onto it, avoiding excessive compression on the posterior surface of the thigh and promoting the return of blood circulating in the veins of the leg towards the heart.

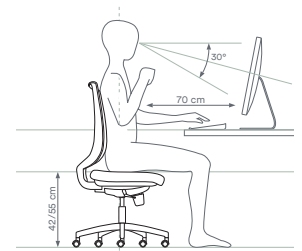

finiture base



Polished aluminium



Black nylon

mesh

Black



fabrics

Cat. B

Bondai



Cat. H

Madrid 3D



Boss FR (eco-leather)



Cat. D

King Flex



Time



Skill (eco-leather)

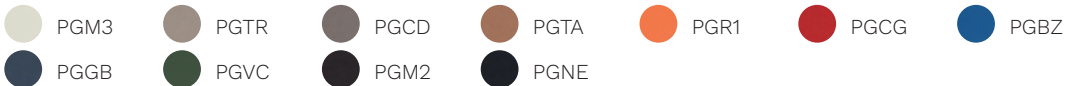

Cat. F

Step

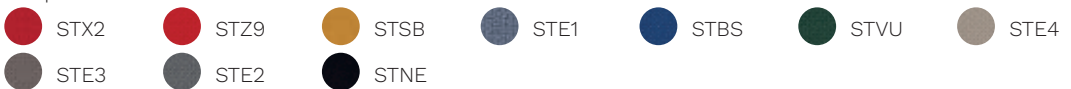

Chili

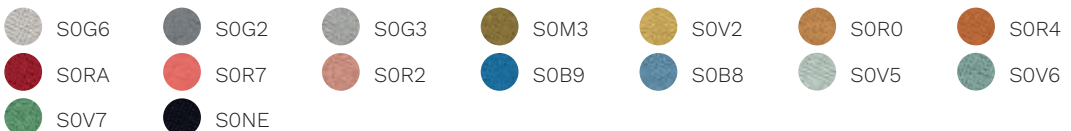

Stromboli



Silvertex

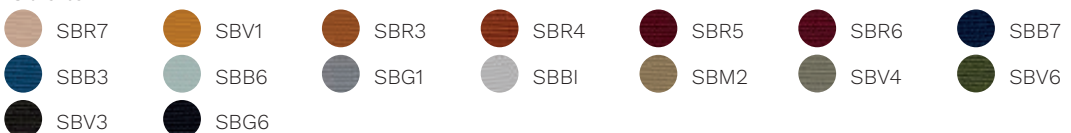

Valencia



Jet



Magnum (eco-leather)

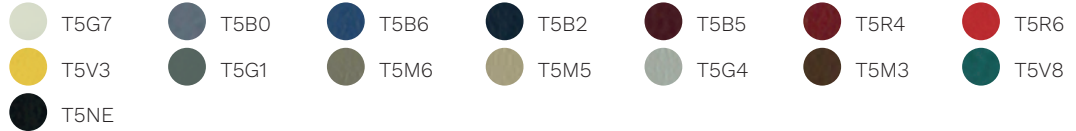

Connect

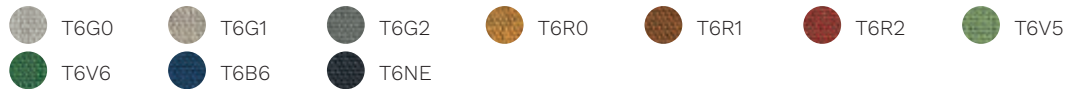

Rivet



Era



Go Check

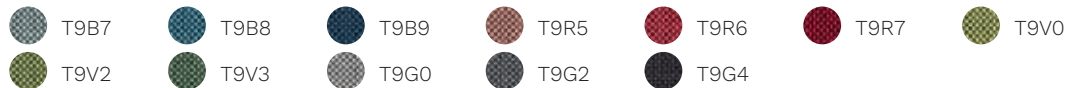

Rondo

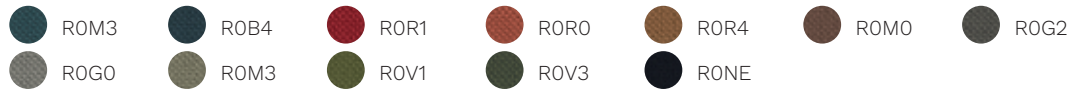

Cat. G

Focus

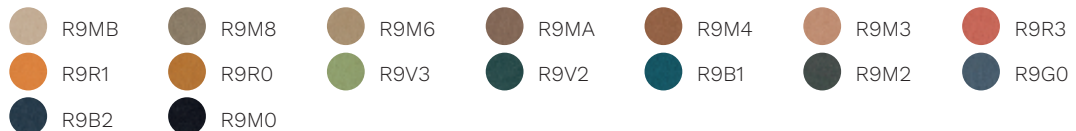

Focus Melange



Savanna

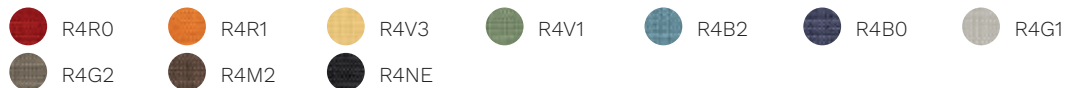

ABACUS

Synchronised lockable in 4 positions

Without armrests

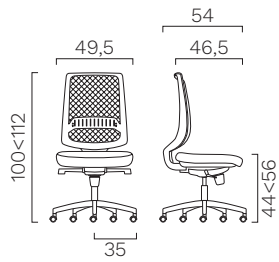

Synchronised lockable in 4 positions with seat depth adjustment

Without armrests

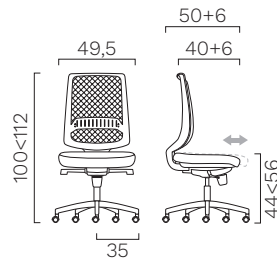

With fixed armrests

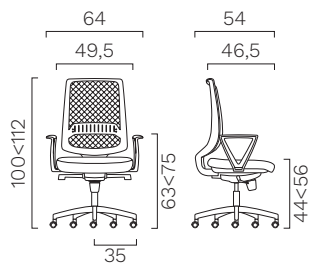

With fixed armrests

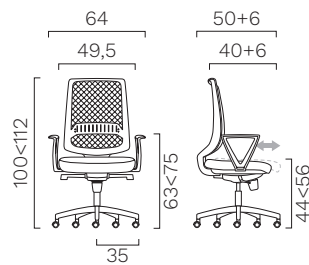

With 1D adjustable armrests

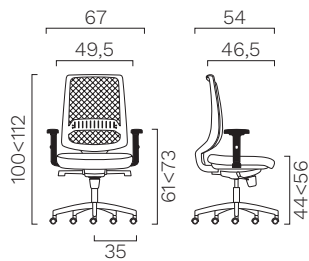

With 1D adjustable armrests

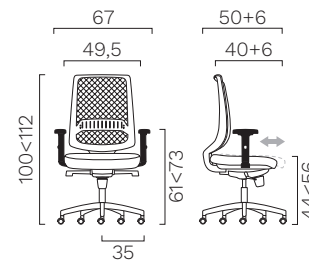

With 1D adjustable armrests + headrest

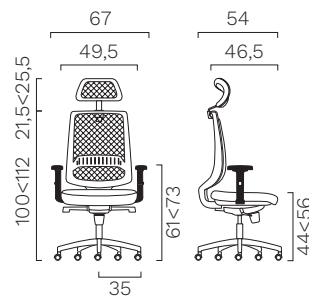

With 1D adjustable armrests + headrest

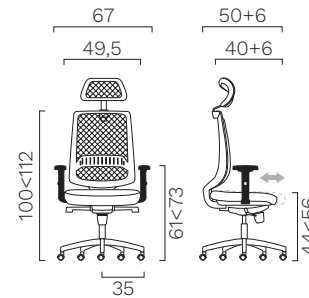

With 2D adjustable armrests

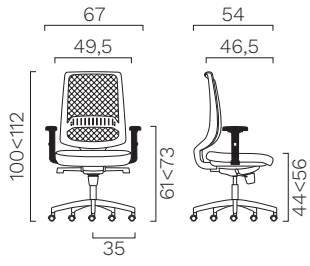

With 2D adjustable armrests

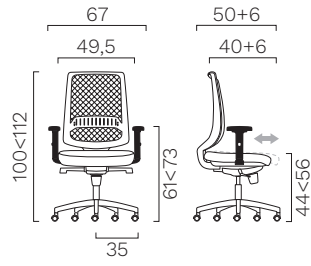

With 2D adjustable armrests + headrest

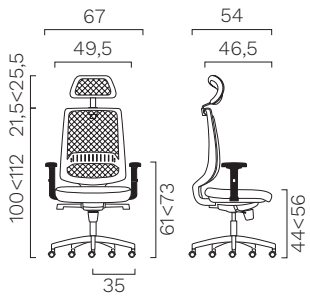

With 2D adjustable armrests + headrest

