

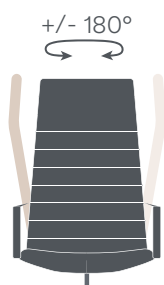

### CARATTERISTICHE TECNICHE

monoscocca	imbottitura in poliuretano schiumato a freddo, ignifugo, esente da CFC, con inserto in acciaio; rifinitura con cuciture orizzontali. La monoscocca è inclinata di 6° indietro.
ottomano	struttura in multistrato di faggio e imbottitura in poliuretano flessibile ed indeformabile, esente da CFC.
braccioli	<u>in poliuretano</u> schiumato a freddo, completamente rivestiti. <u>in alluminio</u> con poggiaabbraccia rivestito in tinta con la seduta.
meccanismo monoscocca	<u>oscillante con ritorno automatico</u> che permette una leggera oscillazione della scocca (angoli di oscillazione 7° indietro, 4° in avanti) e una rotazione di 180° a dx e 180° a sx.



meccanismo ottomano	<u>3D</u> con elevazione a gas. Permette un movimento frontale, laterale e posteriore di 3° del sedile ed un'elevazione di 7 cm.
---------------------	--

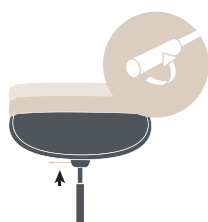

leva a destra per regolare l'altezza della seduta

base	<u>a 4 razze</u> in alluminio lucido o verniciata nera su piedini (Ø 82 cm per Key Lounge, Ø 72 cm per Ottomano).
------	---

finiture basi



Alluminio lucido



Alluminio nero

**Cat. D**

Skill (ecopelle)

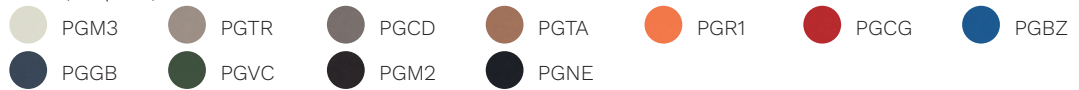

**Cat. F**

Step

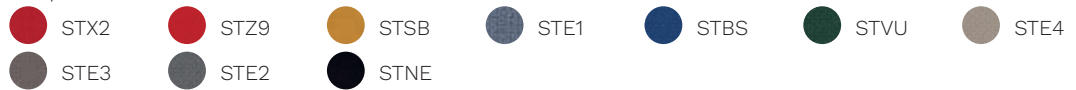

Chili

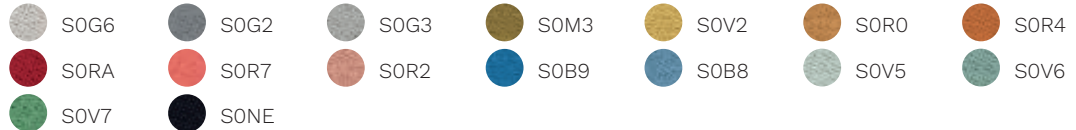

Stromboli



Silvertex

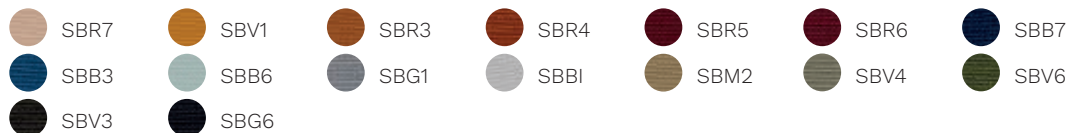

Valencia



Jet



Magnum (ecopelle)

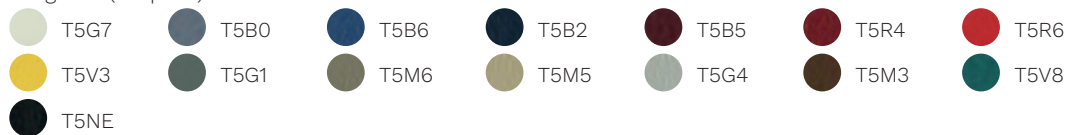

Connect

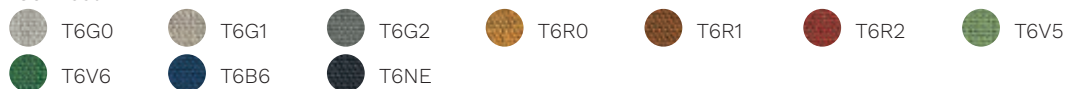

Rivet

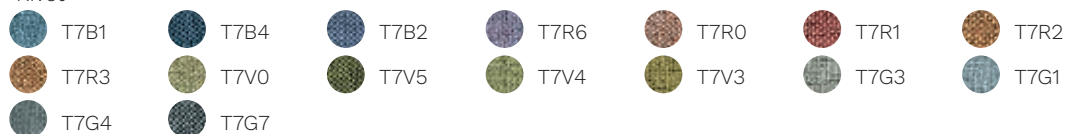

Era



Go Check  
 T9B7  T9B8  T9B9  T9R5  T9R6  T9R7  T9V0  
 T9V2  T9V3  T9G0  T9G2  T9G4











Rondo  
 R0B3  R0B4  R0R1  R0R0  R0R4  R0M0  R0G2  
 R0G0  R0M3  R0V1  R0V3  R0NE

**Cat. G**

















Remix 3

 RIO3  RIRB  RIRG  RIRE  RIBR  RIO1  RIMC  
 RITA  RIBE  RIEC  RIH2  RIGC  RILV  RIB4  
 RIA4  RIB1  RIV4  RIGB  RIG2  RIR2  RIV1  
 RIO4  RIYE  RIV3  RIGR

Morph

 R3B0  R3M0  R3R1  R3R2  R3R4  R3B2  R3V5  
 R3V3  R3V1  R3G2

Focus

 R9MB  R9M8  R9M6  R9MA  R9M4  R9M3  R9R3  
 R9R1  R9R0  R9V3  R9V2  R9B1  R9M2  R9G0  
 R9B2  R9M0

Focus Melange

 R8M4  R8M6  R8R1  R8V3  R8V7  R8G9  R8G0  
 R8B2  R8B1  R8M5  R8R4  R8M0  R8M1  R8G3  
 R8G4  R8G5

Aida















 S3VA  S3MD  S3R8  S3R0  S3MC  S3R5  S3R1  
 S3R3  S3V2  S3BC  S3B0  S3VD  S3V4  S3G1  
 S3G2

**Cat. Q**















Steelcut Trio 3

 SYR1  SYRO  SYRC  SYRF  SYRE  SYRR  SYMG  
 SYMA  SYMS  SYBB  SYB1  SYA1  SYAZ  SYV4  
 SYVM  SYGC  SYV1  SYRG  SYG1  SYAT

Ecriture

 S4B1  S4M0  S4M1  S4M2  S4V1  S4M3  S4V0  
 S4V2  S4V3  S4NE  S4G2  S4G1  S4G3  S4R0  
 S4M4

Ombra

 S5R4  S5R3  S5R0  S5R2  S5M0  S5V2  S5V1  
 S5V0  S5G0  S5R1  S5G1  S5B2  S5B1  S5B0  
 S5G2

**Cat. P**

Pelle

**Cat. PX**

Pelle Fiore

**Cat. X**

Elmosoft

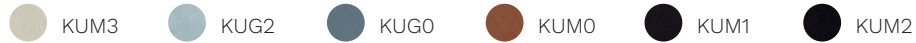

Montana

**ABACO**

Schienale alto.

Meccanismo oscillante con ritorno automatico.

Braccioli imbottiti e rivestiti.

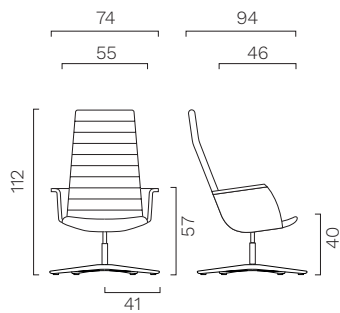

Schienale alto.

Meccanismo oscillante con ritorno automatico.

Braccioli imbottiti e rivestiti.

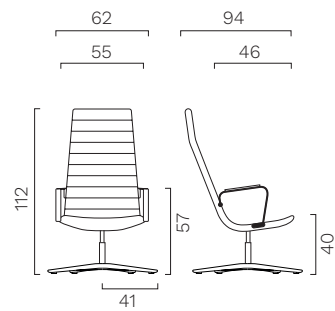

Schienale alto.

Meccanismo oscillante con ritorno automatico.

Senza braccioli.

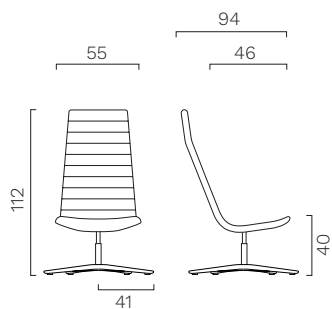

## Ottomano

Meccanismo 3D con elevazione a gas.

