



TECHNICAL DETAILS

design Marco Zito

system	consisting of two sofas (W. 140 or W. 160 cm) and privacy panels. It is possible to integrate, separately, a monitor totem with power/data connection sockets on the side, and fixed or adjustable height tables.
structure	die-cast aluminium epoxy powder-coated in embossed white RAL 9010, black RAL 9005 or dove grey. Adjustable feet +20 mm.
seat	consisting of a 20 mm thick plywood panel with flexible polyurethane padding, covered with fire retardant wadding (100 g). Upholstery in fabric or eco-leather. Seat height 38 cm.
dividing panel	made of a 20 mm thick multilayer wood panel, integrated with PF 40 polyurethane on both sides. Upholstered in fabric (no eco-leather). Dimensions W. 3 cm H. 118 cm
accessories	<p><u>coat hanger</u>: made of 2 mm thick folded sheet steel painted with epoxy powder with embossed finish.</p> <p><u>magazine holder</u>: made of 2 mm thick folded sheet steel painted with epoxy powder with embossed finish.</p> <p><u>sockets</u>: equipped with 1 plug (Shuko DE or UK) or 1 socket with 2 USB 5V A+C. Fixed to the sofa frame.</p> <p><u>cable duct</u>: in polyester with zip closure.</p> <p><u>tables</u>: fixed or height adjustable by gas lift. Melamine top 18 mm thick and metal structure painted white RAL 9010, dove grey or black RAL 9005.</p>

structure finishes

Embossed painted aluminium

- ZGBI - White
RAL 9010
- ZGTR - Dove Grey
- ZGNE - Black
RAL 9005

table top finishes

Melamine

- MBI
White
- MTR
Dove Grey
- MCE
Cement
- MOB
Light elm
- MNC
Walnut

accessories

Painted metal

- ZGBI
White
- ZGTR
Dove Grey
- ZGNE
Black

Cat. H

Madrid 3D



Cat. D

King Flex



Time



Skill (eco-leather)

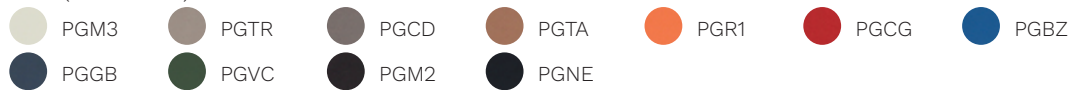

Cat. F

Step



Chili

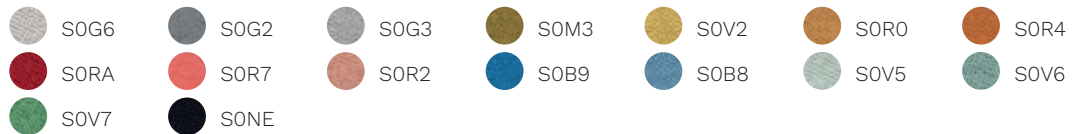

Stromboli



Silvertex

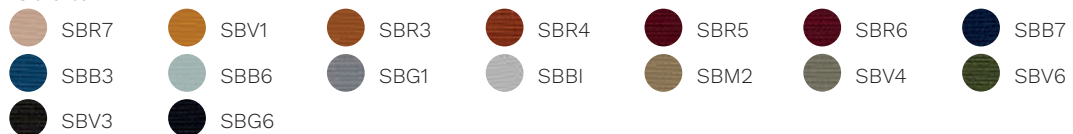

Valencia



Jet



Magnum (eco-leather)

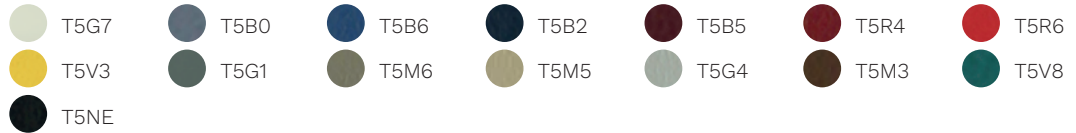

Connect

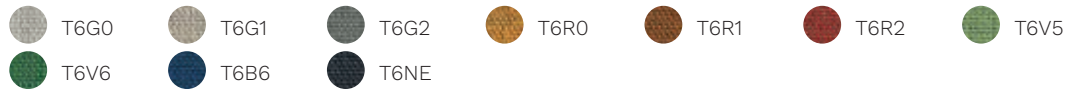

Rivet



Era



Go Check

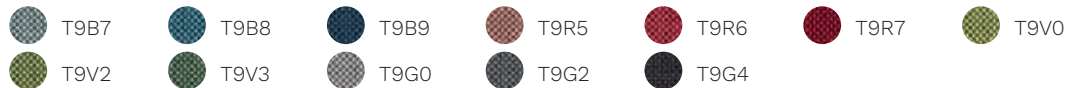

Rondo

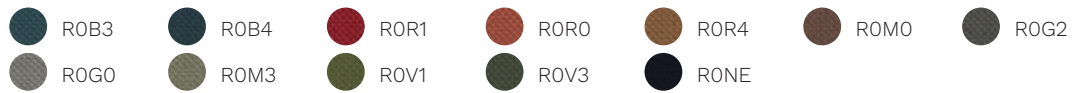

Cat. G

Remix 3



Oceanic

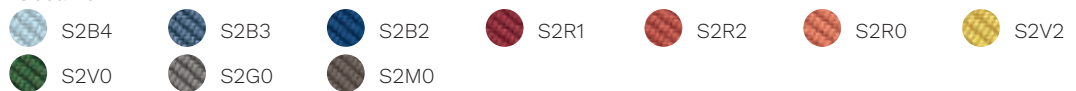

Focus

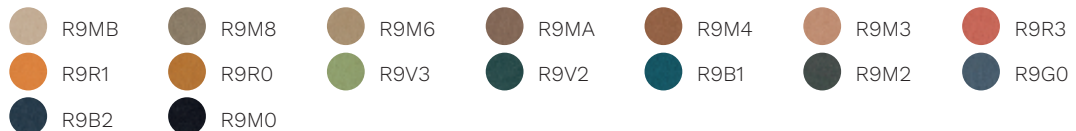

Focus Melange



Aida



Cat. Q

Steelcut Trio 3



Ecriture

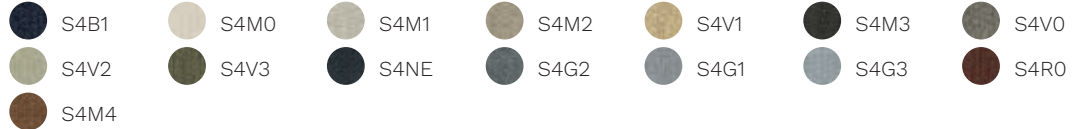

Ombra

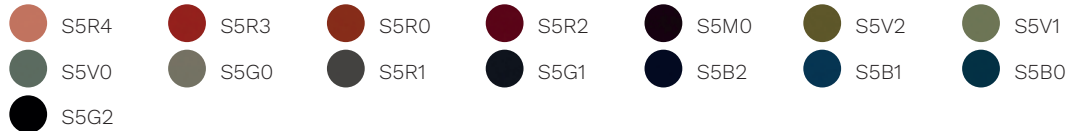

Cat. P

Leather



Cat. PX

Corrected grain leather



Cat. X

Elmosoft



Montana



ABACUS

Meeting Pod

Meeting Pod composed of: sofa W. 140 x D. 60 cm (x2).
Kit of 6 panels upholstered in fabric.

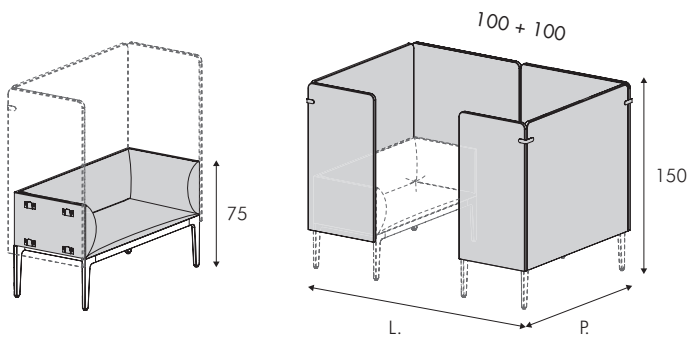

Meeting Pod composed of: sofa W. 160 x D. 60 cm (x2).
Kit of 6 panels upholstered in fabric.

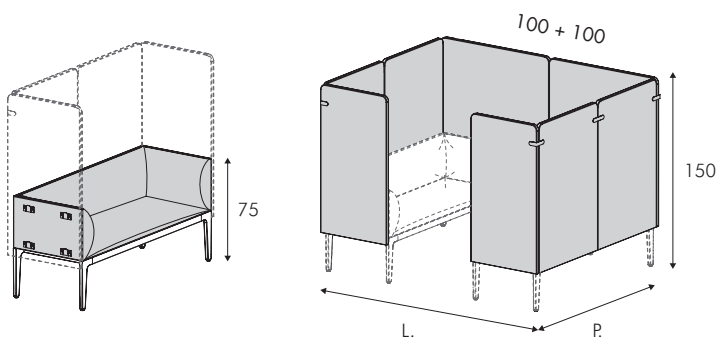

Mediawall

Mediawall. 28 mm thick melamine exterior panel. 2 side openings for sockets. 2 side holes Ø 60 mm for cable outlet.

Mediawall. Fabric-covered plywood panel (total thickness 30 mm). 2 side openings for sockets. 2 side holes Ø 60 mm for cable outlet.

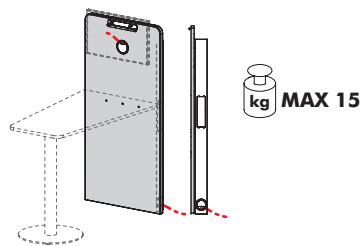
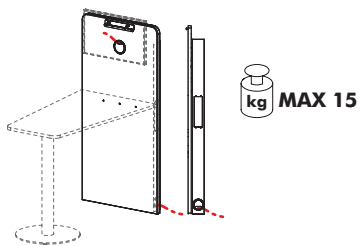

Trapezoidal table for Mediawall.
18 mm thick melamine top.

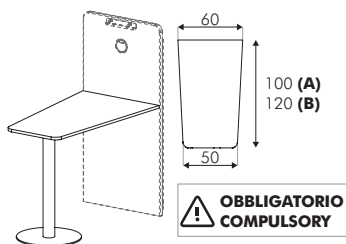

Tables

Trapezoidal table for Mediawall.
Height adjustment by gas lift system.

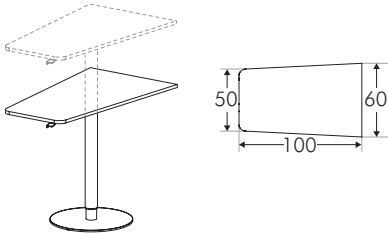

Square table 60x60cm for Mediawall.
Height adjustment by gas lift system.

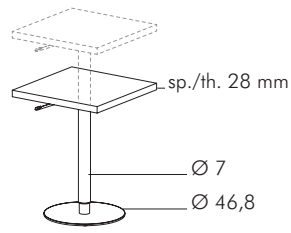

Accessories

Coat hanger.

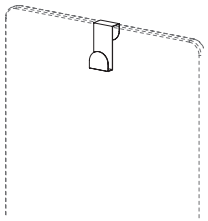

Magazine holder.

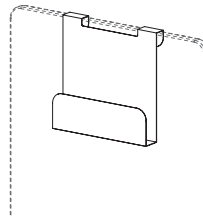

Electrification

NETBOX MEB 3 - Box 3 modules
(2 power e 1 HDMI).

